

## **Requirements and Procedures to File a Request to CIPO for the PPH Pilot Project between CIPO and the NBPR**

### **Request to CIPO for accelerated examination under PPH**

An applicant should file a request for accelerated examination under the Patent Prosecution Highway (PPH) to CIPO by submitting a letter requesting accelerated examination under the PPH accompanied by a completed PPH request form and the relevant supporting documents. The PPH request form must be the uppermost document to ensure that the request is correctly processed. The PPH request form is given in Annex A and is also available online at the CIPO PPH website.

### **Requirements for requesting accelerated examination under the PPH pilot project at CIPO**

There are five requirements for requesting accelerated examination under the PPH pilot project at CIPO. These are:

- (a)** The CIPO application is either:
- (i) a nationally filed application which validly claims priority under the Paris Convention from either a single NBPR national application or multiple NBPR national applications; or
  - (ii) a nationally filed application which validly claims priority under the Paris Convention from a PCT application which has no priority claims; or
  - (iii) a PCT national phase application where the PCT international application has validly claimed priority from a NBPR national application or multiple NBPR national applications; or
  - (iv) a PCT national phase application where the PCT international application has no priority claims; or
  - (v) a PCT national phase application where the PCT international application has validly claimed priority from a PCT international application which has no priority claims; or
  - (vi) a divisional of an application referred to in any of (i) to (v).

Illustrated examples of Canadian patent applications that may request accelerated examination under the PPH pilot project at CIPO are given in Annex D.

- (b)** At least one corresponding NBPR national application has one or more claims that are determined to be allowable by the NBPR.

The corresponding application should not be necessarily interpreted as the application which forms the basis of the priority, but may be the application which derived from the application which forms the basis of the priority or from the PCT application which has no priority claim; e.g., a divisional application of the application or an application which claims internal priority to the application. Where the OFF application that contains the allowable/patentable claims is not the same application for which priority is claimed in the OSF application, applicant must identify the relationship between the OFF application that contains the allowable/patentable claims and the OFF priority application claimed in the OSF application (e.g. OFF application X that contains the allowable/patentable claims, claims domestic priority to OFF application Y, which is the priority application claimed in the OSF application).

CIPO shall consider corresponding NBPR claims to be allowable as indicated in a NBPR Granted Patent Publication and/or in the office action entitled “Hyväksyvä välipäätös” (Communication of Approval).

The following indications of allowable subject matter are not eligible for the PPH: a positive opinion is shown in the ISR, WO/ISA, WO/IPEA, IPER, or IPRP of the PCT international phase, but the NBPR has not determined the claims to be patentable/allowable yet; and/or Examination was conducted in the European Patent Office (EPO) and the patent right was validated in the NBPR as a designated state.

**(c)** All claims on file, as originally filed or as amended, for accelerated examination under the PPH must sufficiently correspond to one or more of those claims indicated as allowable in the NBPR.

Claims shall be considered to sufficiently correspond where, except for differences due to translations and claim format, the claims on file are of the same or similar scope as the claims in the NBPR, or the claims on file are narrower in scope than the claims in the NBPR.

In this regard, a claim on file which is narrower in scope occurs when a NBPR claim is amended to be further limited by an additional technical feature that is supported in the specification (description and/or claims). If possible, the claim on file should be presented in dependent form.

A claim on file which introduces a new/different category of claims to those claims indicated as allowable in the NBPR is not considered to sufficiently correspond.

An example of claims on file which comply with requirement (c) is given in Annex C.

**(d)** The CIPO application is open to public inspection.

**(e)** CIPO has received a request for examination, but has not begun examination of the application.

### **Required documents for accelerated examination under the PPH pilot project at CIPO**

The following relevant documentation will be needed to support a request for accelerated examination under the PPH pilot project at CIPO:

**a)** a translation into English or French of the NBPR Granted Patent Publication (where available), and all the NBPR office action(s) issued in the corresponding NBPR application(s). The applicant is required to provide a professional translation of the office action(s) in order to ensure the accuracy of the translation. The CIPO examiner will use the translation to understand at least the outline of the office action(s).

**b)** a translation into English or French of the claims indicated as allowable by the NBPR.

An applicant is required to provide a professional translation of the claims in order to ensure the accuracy of the translation. The CIPO patent examiner will use the translation to understand the scope of the claims and to determine the requirement of claim correspondence.

**c)** a completed claim correspondence table showing the relationship between the claims of the CIPO application for accelerated examination under the PPH and the claims of the corresponding NBPR application considered allowable by the NBPR. A sample claim correspondence table is given in Annex B.

The applicant is required to provide copies of the relevant documentation with the request for

---

<sup>1</sup> The NBPR office action documents include “Hyväksyvä välipäätös” (Communication of Approval), “Välipäätös” (Technical Office Action) and “tutkimusraportti” (Search Report).

accelerated examination under the PPH. Please note that the applicant is not required to submit a copy of the Finnish language version of these documents but is required to submit a translation thereof. Translations of a NBPR Granted Patent Publication should be accompanied by a copy of the cover page of the original Granted Patent Publication.

An applicant is required to submit English or French language translations of the relevant documentation. If necessary, the examiner can request the applicant to resubmit translations. A request for the PPH will not be rejected on the basis that the translation is inadequate until after at least one opportunity is given to submit adequate translations.

Where not publicly available, copies of the patent documents cited by the NBPR must be provided with the request. Non-patent literature cited by the NBPR should always be submitted.

The CIPO patent examiner may requisition translation of citations using the standard CIPO examination procedure (section 29 of the *Patent Rules*) where translation of a cited document is necessary. However, applicants may file translations as part of the supporting documentation when initially requesting accelerated examination under the PPH to allow prompt consideration of the citations, if they so desire.

The applicant need not provide further copies of documentation if the applicant has already submitted the documents noted above to CIPO through simultaneous or past procedures related to the application.

### **Procedures for filing a request for accelerated examination under the PPH pilot project at CIPO**

The applicant files a letter requesting accelerated examination under the PPH pilot project to CIPO, a completed PPH request form, and the relevant supporting documents as noted above.

The request for examination under PPH may be made by mail, fax, or electronically via the Industry Canada website as per the CIPO patent correspondence procedures. The PPH request form must be the uppermost document to ensure that the request is correctly processed. The PPH request form is given in Annex A and is also available online at the CIPO PPH website.

All subsequent correspondence with the office must be clearly identified as a PPH pilot project application to ensure that the correspondence is correctly processed.

The request for accelerated examination under the PPH pilot project must also be accompanied by, or preceded by a request for examination.

If the CIPO application is not open for public inspection at the time of request, the applicant must authorize the application be made open for public inspection in the letter.

It is recommended that the applicant not only focus on the claims when making the PPH request but additionally review the application as a whole and amend the application to correct known informalities that result from the differences between CIPO and NBPR patent application requirements.

These informalities may include defects such as a statement that incorporates by reference another document (section 81(1) of the *Patent Rules*), and reference to documents that are not available to the public (subsection 81(2) of the *Patent Rules*).

### **Procedures of examination under the PPH pilot project at CIPO**

The PPH request will be considered by a patent examiner and if all requirements are met, the examiner will conduct the accelerated examination. Each Canadian patent application will be examined in accordance with the Canadian *Patent Act* and *Rules* and CIPO's Patent Office

## Practice.

If the patent examiner determines that the claims on file do not sufficiently correspond to one or more of those claims indicated as allowable in the NBPR, the applicant will be notified that the request for accelerated examination is not granted. To re-enter the PPH, the applicant must amend the claims accordingly and reapply altogether.

At any time during the prosecution of a PPH application, if the patent examiner determines that the claims on file do not sufficiently correspond to one or more of those claims indicated as allowable in the NBPR, the applicant will be notified that the application will await action in its regular turn.

All amendments to the claims made with the request for accelerated examination under the PPH pilot will be entered regardless of whether the request is granted or not.

**ANNEX A**

**PPH Pilot Project Request Form**

**Request for Accelerated examination at CIPO under the PPH Pilot Project between CIPO and the NBPR**

**Application Information**

CIPO application number:

Corresponding NBPR application  
or publication number(s):

---

---

**Claims on file and Claim Correspondence Table**

Either:

(a) The claims on file correspond to one or more of those claims indicated as allowable in the NBPR; or

(b) The applicant is amending the claims with this request to correspond with one or more of those claims indicated as allowable in the NBPR

and

A claim correspondence table is completed.

**Translation of the corresponding NBPR claims**

A copy of an accurate translation of those claims indicated as allowable in the NBPR is attached.

**Corresponding NBPR required documents**

(a) An accurate translation of the NBPR office actions is attached; and

(b) An accurate translation of the NBPR Granted Patent publication and a copy of the cover page is attached (where available).

**Other Amendments to application (Optional)**

Either:

(a) The applicant has reviewed the application, the specification on file conforms with Canadian patent application requirements and practice; or

(b) The applicant is amending the specification to conform with Canadian patent application requirements and practice.

## **ANNEX B**

### **Claim Correspondence Table**

<b>CIPO application claim on file</b>	<b>Corresponding OFF claim</b>	<b>Comment</b>

Examples:

### **Claim Correspondence Table**

<b>CIPO application claim on file</b>	<b>Corresponding OFF claim</b>	<b>Comment</b>
1 to 5	1 to 5	Applicant has amended the claims to the present claims having the same scope as the claims of the applicant's corresponding OFF application. OFF claims 1 to 5 have been indicated as allowable in the notice dated __.
1 to 3	1 to 3	Applicant has amended the claims to the present claims having the same scope as the claims of the applicant's corresponding OFF application. OFF claims 1 to 3 have been indicated as allowable in the office action dated __.

## **ANNEX C**

With regard to requirement (c), the claims in the following example are considered to "sufficiently correspond":

**Claim Correspondence Table**

<b>CIPO claims</b>	<b>Subject matter</b>	<b>OFF claims</b>	<b>Subject matter</b>	<b>Comment</b>
1	A	1 (independent)	A	The same as OFF claim 1.
2	A + a + b	2 (dependent on 1)	A + a	Claim 2 has the additional technical feature "b" on the OFF claim 2.
3	A	3 (dependent on 1)	A + b	Similar to OFF claim 1 except for claim format.
4	A + d			Claim 4 has an additional technical feature "d" on the OFF claim 1. Where "d" is supported in the description but is not claimed in the OFF.
<i>Where "A" is the subject matter and "a", "b", and "d" are the additional technical features which narrow (further restrict) the scope of the subject matter.</i>				

A CIPO claim which introduces a new/different category of claims to those claims indicated as allowable in the OFF is not considered to sufficiently correspond. For example, the OFF claims only contain claims to a process of manufacturing a product, then the CIPO claims are not considered to sufficiently correspond if the CIPO claims introduce product claims which are independent or dependent on the corresponding process claims.

Note, it is not necessary to include "all" claims determined to be allowable in the OFF in an application in CIPO (the deletion of claims is allowable). For example, in the case where an application in the OFF contains 5 claims determined to be patentable/allowable, the corresponding application in CIPO may contain only 3 of these 5 claims.

## ANNEX D

Examples of Canadian patent applications that may request accelerated examination under the PPH pilot project at CIPO:

- (A) (i) a nationally filed application which validly claims priority under the Paris Convention from either a single OFF national application or multiple OFF national applications

### Example A:

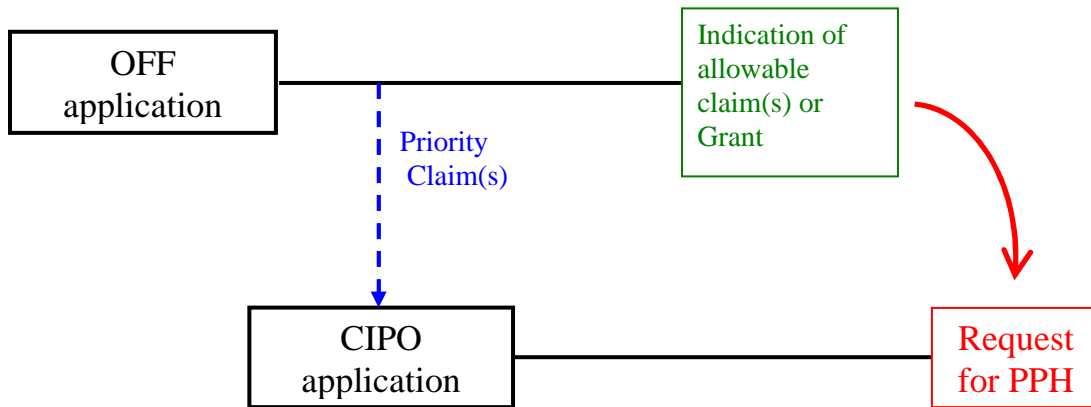

### Example B:

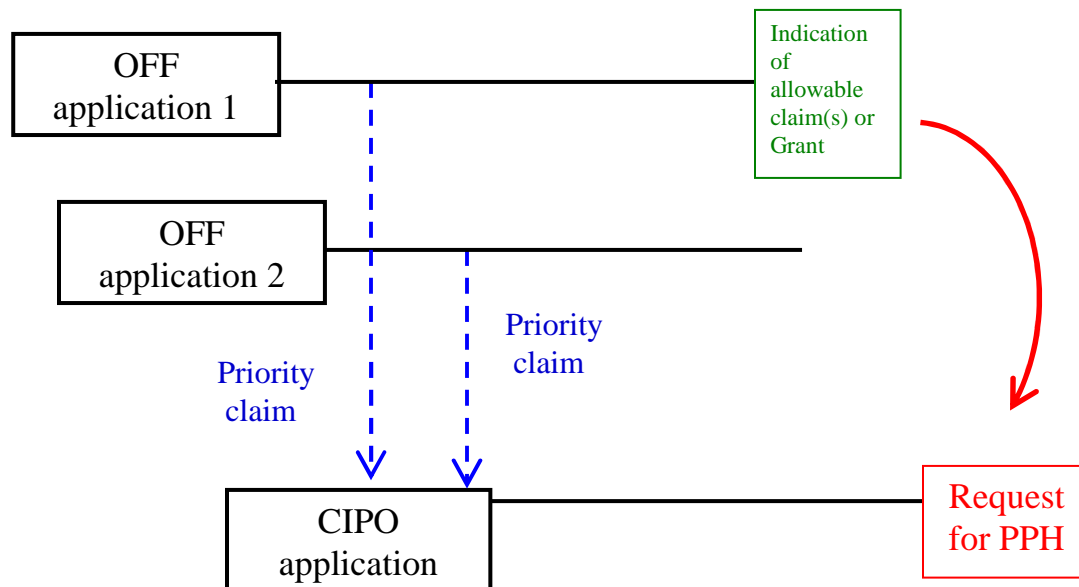

**Example C:**

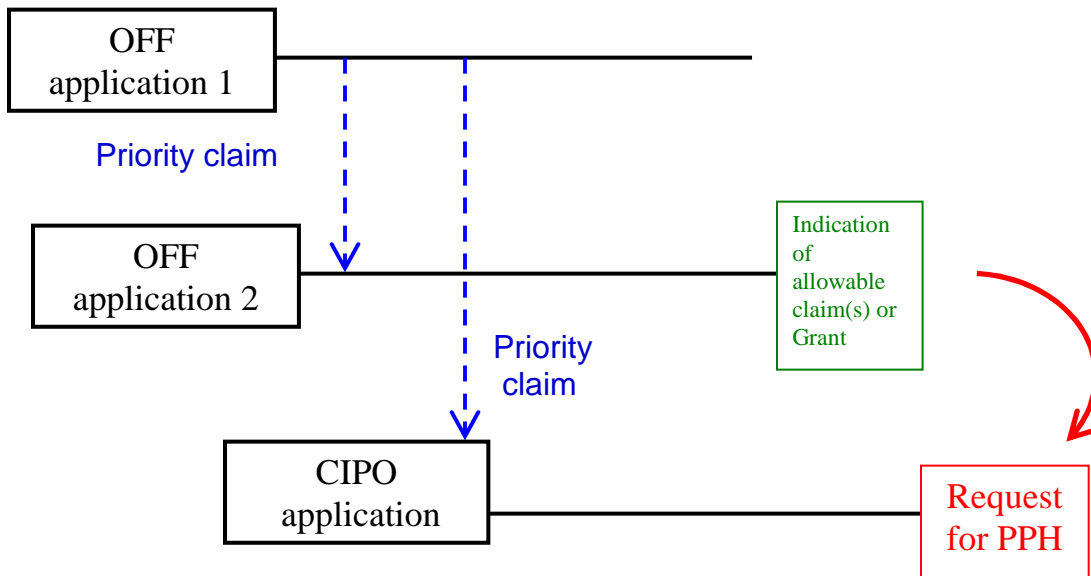

(A) (ii) a nationally filed application which validly claims priority under the Paris Convention from a PCT application which has no priority claims

**Example D:**

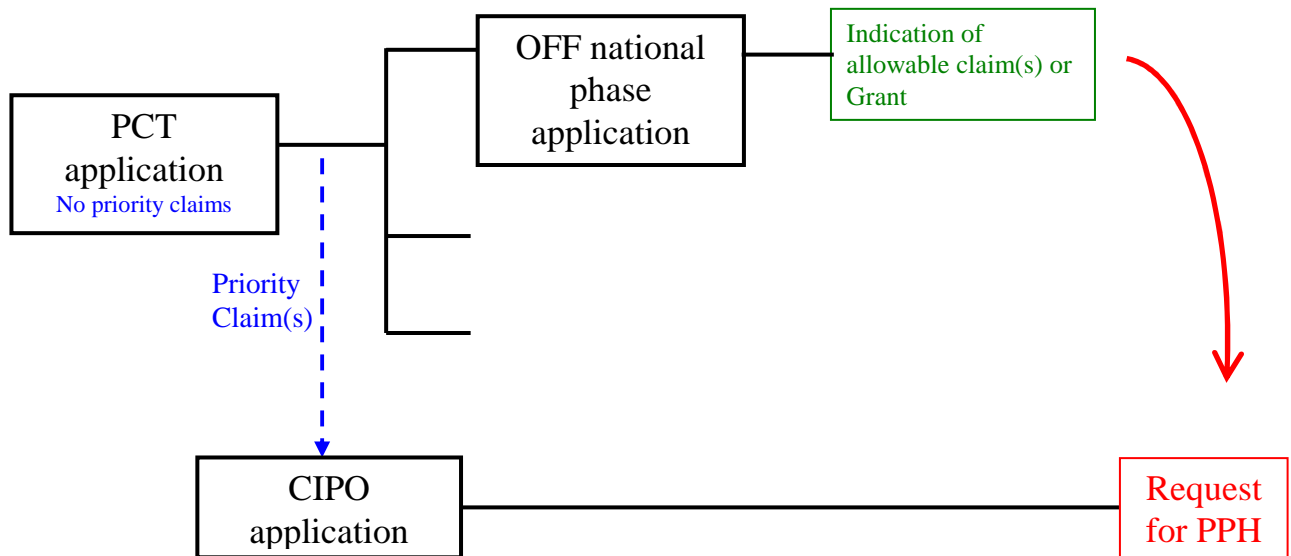

(A) (iii) a PCT national phase application where the PCT international application has validly claimed priority from an OFF national application or multiple OFF national applications

**Example E:**

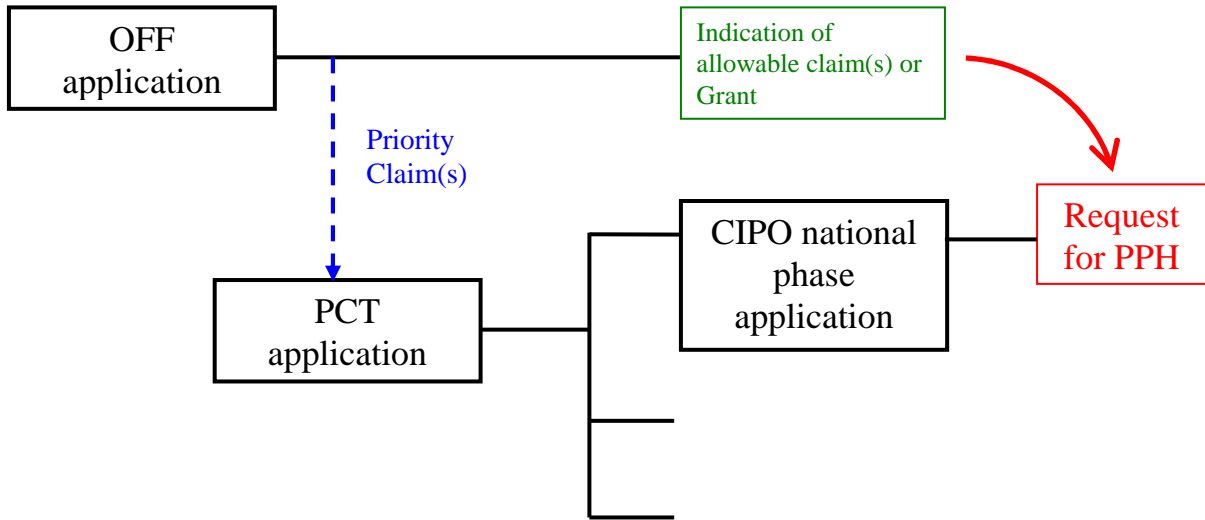

(A) (iv) a PCT national phase application where the PCT international application has no priority claims

**Example F:**

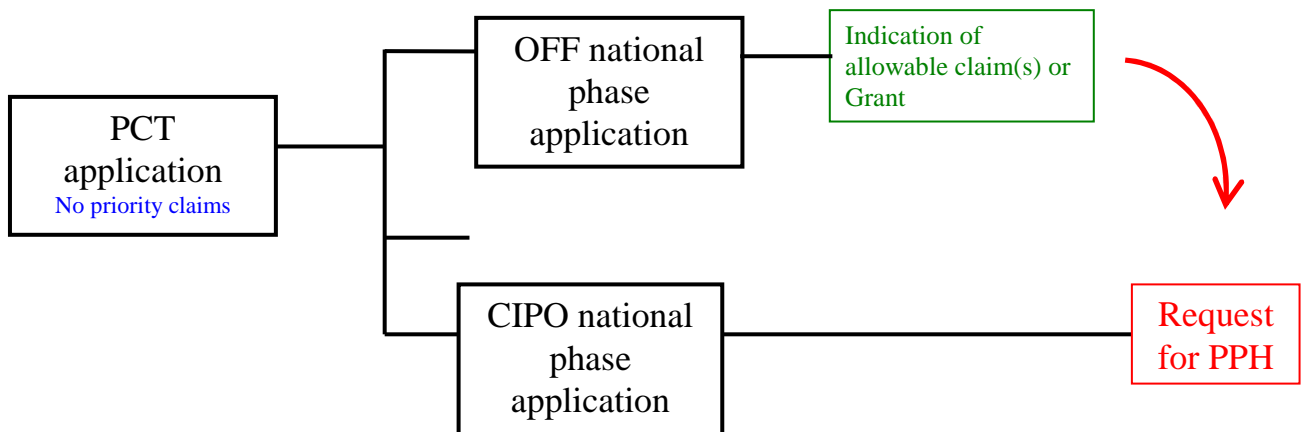

(A) (v) a PCT national phase application where the PCT international application has validly claimed priority from a PCT application which has no priority claims

**Example G:**

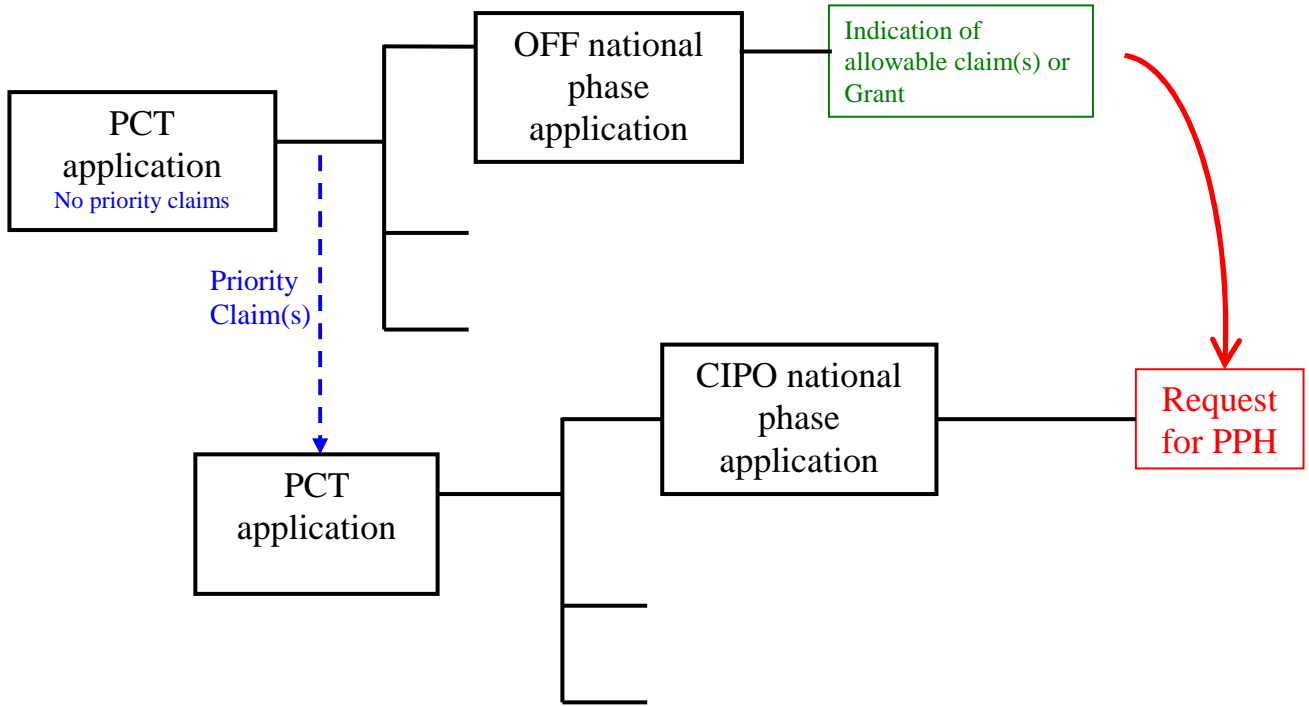

**Example H:**

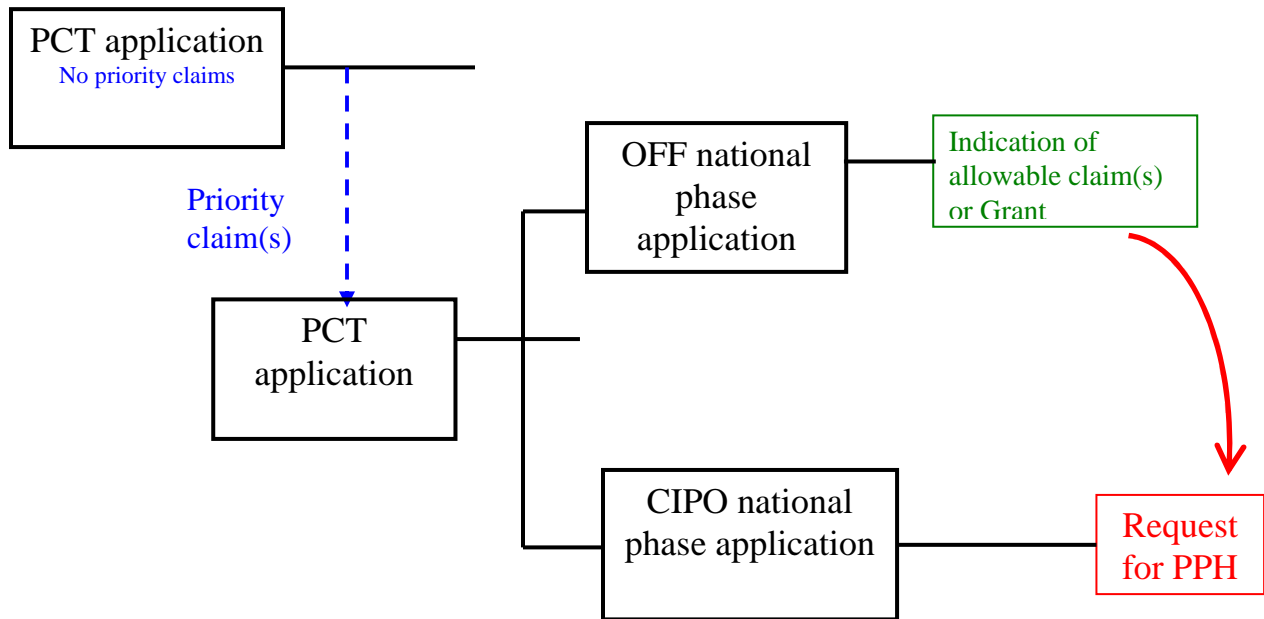

(A) (vi) a divisional of an application referred to in any of (i) to (v)

**Example I:**

